

ORDER EXAMPLE

To correctly order this model follow the example specified below:

PRODUCT	BA10X#080050 0B1 ST SPA
BA10X#080050	Article code found in the prices table on the side
0B1	Connector code found in the table here below
ST	Standard Support code found in the table here below
SPA	Brushed stainless steel code
ACCESSORIES	
Z1TMNR#AN R12 SPA	Valve and Lockshield - stainless STEEL Copper Angle 1/2"
Z1RACX#R12SPA	12mm diam. copper pipe unions for Valve+Lockshield – chrome finish (2)

For other types of Valves see the table below or those on pages 271 - 272 - 273 - 274 - 275.

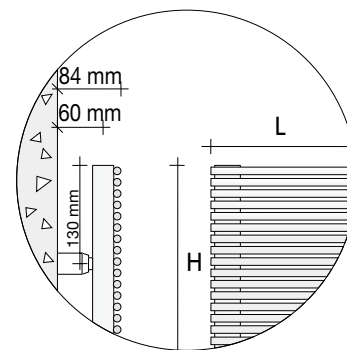

CONNECTORS

The towel warmers are supplied with "0B1" connectors.

If different connectors are required, strictly indicate this in the order. **IMPORTANT:** the connectors of towel warmers and radiators connected to the same system should all have the same configuration otherwise operating problems could occur.

Standard connectors

Will be supplied if not otherwise specified when placing the order

Rear connector

Supplied on request WITH an additional price charge of €

Custom-made connectors

Supplied on request WITH an additional price charge of €

Connectors on request

Supplied on request WITHOUT an additional price charge

Custom-made connectors

Supplied on request WITH an additional price charge of €

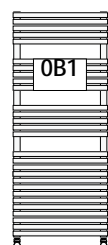

Interaxis (Pipe centre)
l=L-3,4 cm

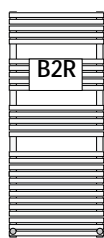

l=L-3,4 cm
rear connector for connection to GVR

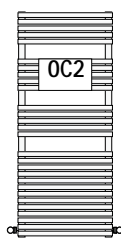

Interaxis (Pipe centre)
l=L+13,8 cm

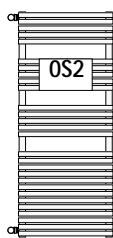

Interaxis (Pipe centre)
l=H-3,8 cm

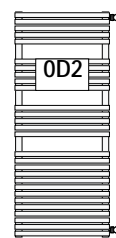

Interaxis (Pipe centre)
l=H-3,8 cm



single pipe

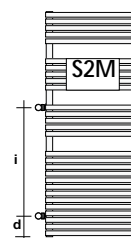

Specify "i" and "d"
i min.=5 cm
d min.=2 cm

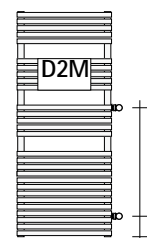

SUPPORTS

The towel warmers are supplied with standard supports (code ST) that include wall fixing shelves, pressure anchors and manual Vent Valve.

On request they can be ordered with bracket supports that are permanently welded on the towel warmers and therefore must be specified when placing the order, their code and cost are as follows:

code MD	WALL TYPE bracket support on the Right	€
code MS	WALL TYPE bracket support on the Left	€
code SO	CEILING TYPE bracket support	€

LIMITS

WALL TYPE bracket support	Width max 60.0 cm
CEILING TYPE bracket support	Width max 80.0 cm

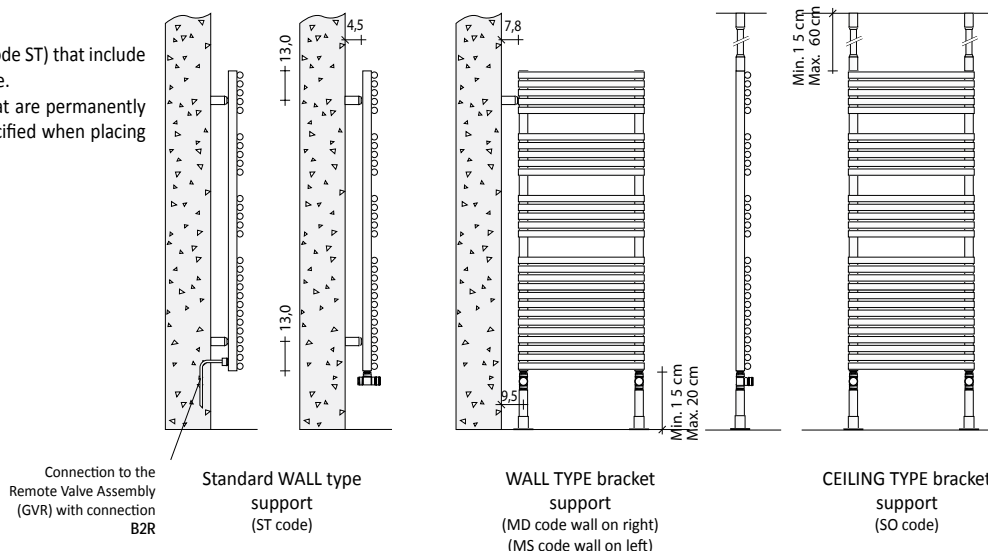

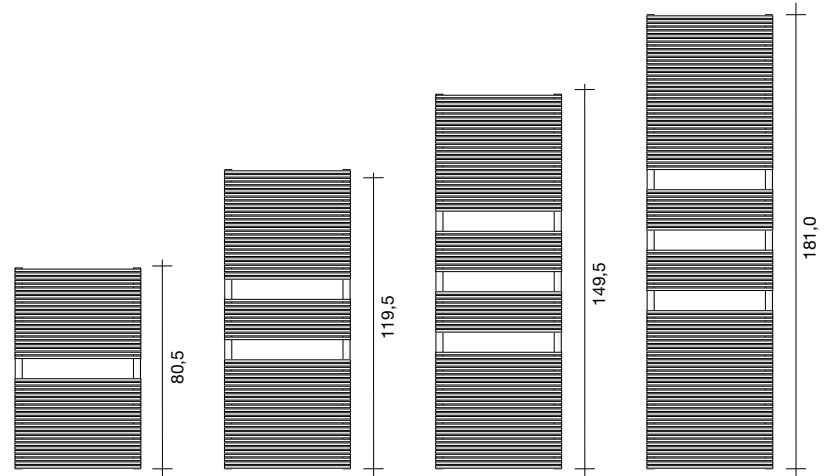

Code	H (cm)	L (cm)	Interaxis (Pipe centre) (cm)	Water Content (l)	Thermal yield		Price Stainless steel (€)
					Watts ΔT 50°C	Watts ΔT 30°C	
BA10X#080040	80,5	40,0	36,6	1,51	297	155	
BA10X#080050		50,0	46,6	1,88	398	208	
BA10X#080060		60,0	56,6	2,26	500	262	
BA10X#120040	119,5	40,0	36,6	2,17	434	225	
BA10X#120050		50,0	46,6	2,71	552	289	
BA10X#120060		60,0	56,6	3,25	670	353	
BA10X#150040	149,5	40,0	36,6	2,64	546	282	
BA10X#150050		50,0	46,6	3,30	678	354	
BA10X#150060		60,0	56,6	3,96	811	429	
BA10X#180040	181,0	40,0	36,6	3,30	665	343	
BA10X#180050		50,0	46,6	4,12	829	432	
BA10X#180060		60,0	56,6	4,95	993	523	

Towel warmers available in stock with OB1 connector

For correction factors different to ΔT50°C/ΔT30°C see page 284-289

REMOTE VALVE ASSEMBLY

code	Description	Price
GVR#	Valve and Lockshield assembly for recessed remote connection, CHROME finish	€
GVRC#	Valve and Lockshield assembly for recessed remote connection, COLOUR finish	€

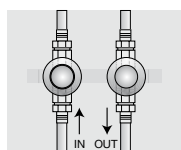

STANDARD VALVES (for Valves and Lockshields, valves that can be fitted with thermostat, Thermostatic valves, or Single pipe, Twin pipe, Stainless steel and thermostatic heads see pages 271, 272, 273, 274 und 275 of the Price List)

code / Description	Price
Z1TMNR#ANR12SPA Paired Valve and Lockshield copper Angle 1/2" STAINLESS STEEL	€
Z1RACX#R12SPA 2 copper unions diam. 12 mm STAINLESS STEEL	€
ZRCFG# Kit with pipe collars for towel warmers CHROME	€

IXSTEEL BA 10X I5

Towel warmer composed of horizontal 10 mm diam. stainless steel elements fusion welded elements with 28 mm diam. manifolds

HW

ORDER EXAMPLE

To correctly order this model follow the example specified below:

PRODUCT	BA10Xi5#080050 0i5 ST SPA
BA10Xi5#080050	Article code found in the prices table here below
0i5	Connector code found in the table here below
ST	Standard Support code found in the table here below
SPA	Brushed stainless steel code
ACCESSORIES	
Z1TMNR#AN R12 SPA	Valve and Lockshield - stainless STEEL Copper Angle 1/2"
Z1RACX#R12SPA	12mm diam. copper pipe unions for Valve+Lockshield – chrome finish (2)

For other types of Valves see the table below or those on pages 271 - 272 - 273 - 274 - 275.

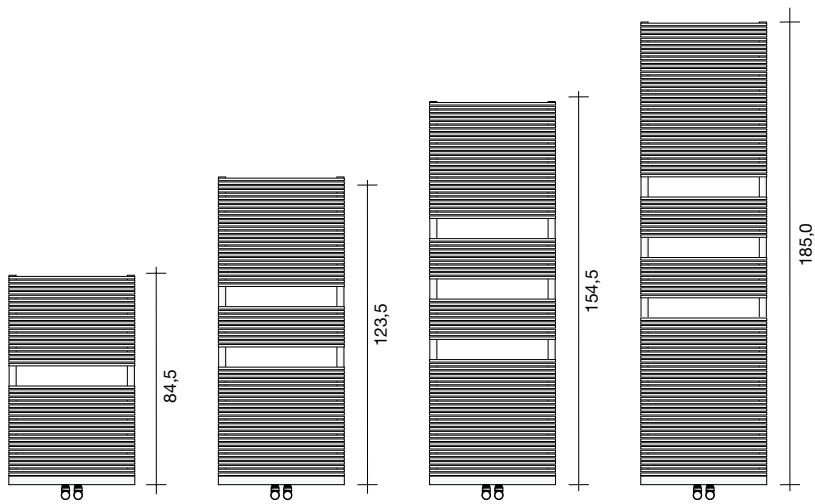
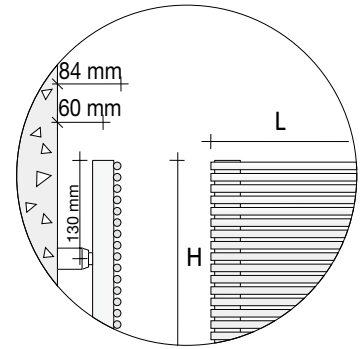

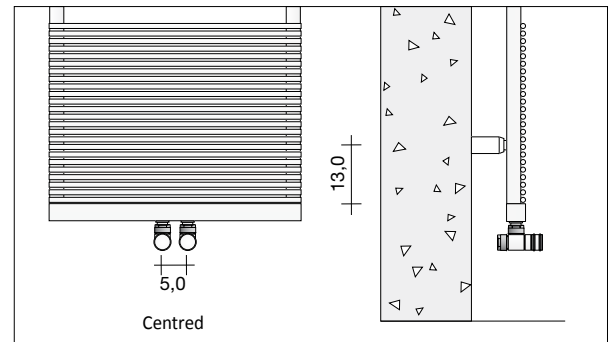

Technical diagram for BA10X i5 connection



Code	H (cm)	L (cm)	Interaxis (Pipe centre) (cm)	Water Content (l)	Thermal yield		Price Stainless steel (€)
					Watts ΔT 50°C	Watts ΔT 30°C	
BA10XI5#080040	84,5	40,0	5	1,51	297	155	
BA10XI5#080050		50,0	5	1,88	398	208	
BA10XI5#080060		60,0	5	2,26	500	262	
BA10XI5#120040	123,5	40,0	5	2,17	434	225	
BA10XI5#120050		50,0	5	2,71	552	289	
BA10XI5#120060		60,0	5	3,25	670	353	
BA10XI5#150040	154,5	40,0	5	2,64	546	282	
BA10XI5#150050		50,0	5	3,30	678	354	
BA10XI5#150060		60,0	5	3,96	811	429	
BA10XI5#180040	185,0	40,0	5	3,30	665	343	
BA10XI5#180050		50,0	5	4,12	829	432	
BA10XI5#180060		60,0	5	4,95	993	523	

For correction factors different to $\Delta T 50^{\circ}\text{C}/\Delta T 30^{\circ}\text{C}$ see page 284-289

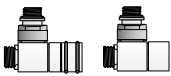
STANDARD VALVES (for Valves and Lockshields, valves that can be fitted with thermostat, Thermostatic valves, or Single pipe, Twin pipe, Stainless steel and thermostatic heads see pages 271, 272, 273, 274 und 275 of the Price List)

code / Description		Price
	Z1TMNR#ANR12SPA Paired Valve and Lockshield copper Angle 1/2" STEEL	STAINLESS STEEL €
	Z1RACX#R12SPA 2 copper unions diam. 12 mm	STAINLESS STEEL €
	ZRCFG# Kit with pipe collars for towel warmers	CHROME €

IXSTEEL BA10XE Electric

Towel warmer composed of horizontal 10 mm diam. stainless steel elements fusion welded elements with 28 mm diam. manifolds

EL

ORDER EXAMPLE

To correctly order this model follow the example specified below:

PRODUCT	BA10XE#080050 U1 ST SPA
BA10XE#080050	Article code found in the prices table on the side
U1	Resistance code listed in the next list
ST	Standard Support code, only one support code available for Electric and Mixed version
SPA	Brushed stainless steel code

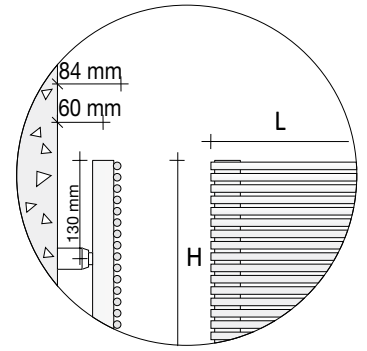

ELECTRIC VERSION WITH EDGE CAP

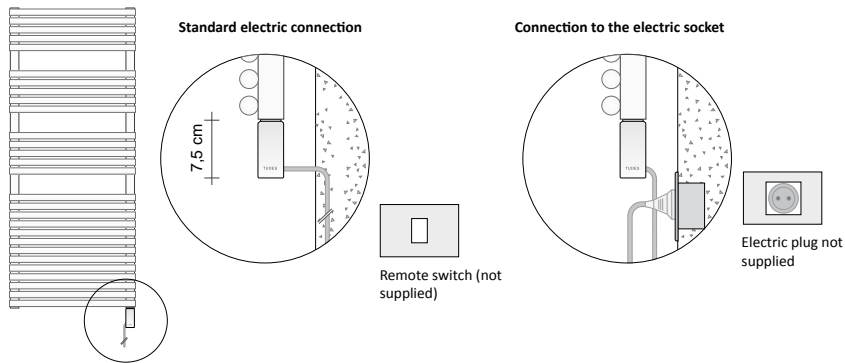

ELECTRIC VERSION WITH THERMOSTAT

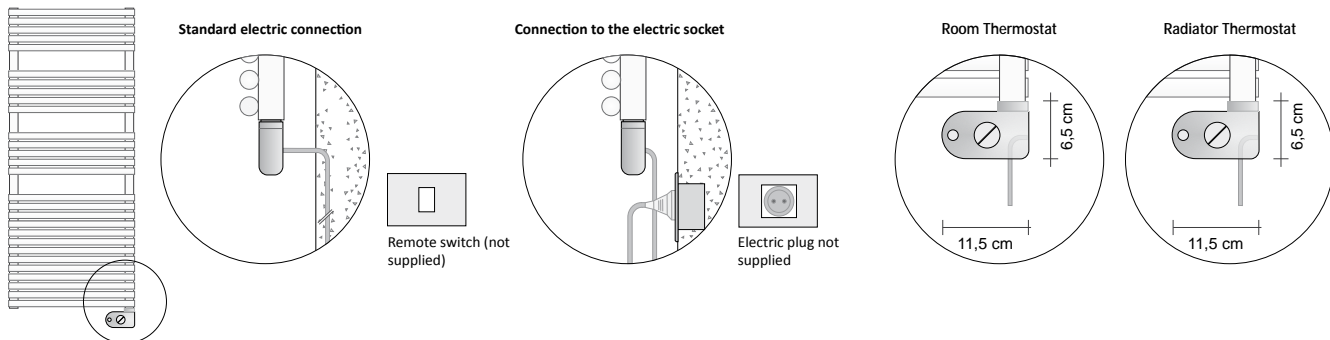

ELECTRIC VERSION WITH WIRELESS THERMOSTAT

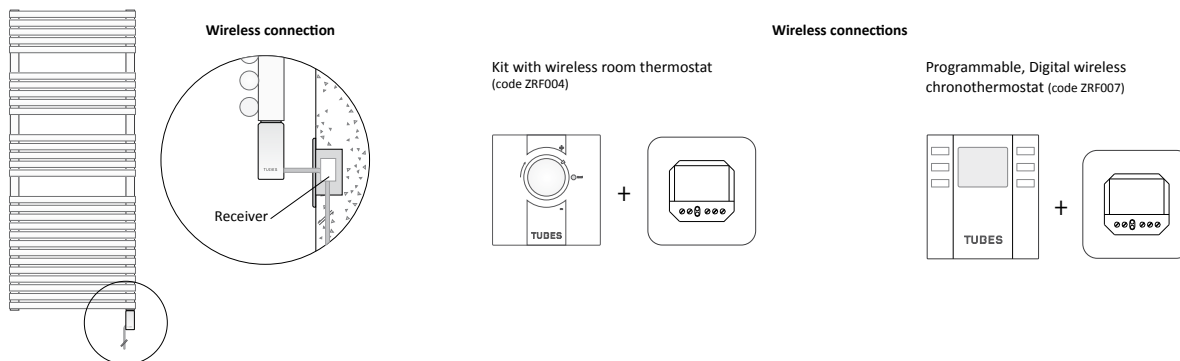

IXSTEEL BA10XE Electric

Price for radiator with Stainless Steel finishing and standard connectors – VAT and transport charges excluded.



ELECTRIC VERSION WITH EDGE CAP

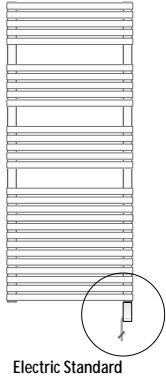

Electric Standard

Model	Edge Cap Colour Code			H (cm)	L (cm)	Electric resistor Watts	Price Stainless steel (€)
	White	Grey	Chrome*				
BA10XE#080040	U1	V1	Z1*	80,5	40,0	300	
BA10XE#080050	U1	V1	Z1*				
BA10XE#080060	U2	V2	Z2*				
BA10XE#120040	U2	V2	Z2*	119,5	40,0	600	
BA10XE#120050	U2	V2	Z2*				
BA10XE#120060	U3	V3	Z3*				
BA10XE#150040	U2	V2	Z2*	149,5	40,0	600	
BA10XE#150050	U3	V3	Z3*				
BA10XE#150060	U3	V3	Z3*				
BA10XE#180040	U3	V3	Z3*	181,0	40,0	900	
BA10XE#180050	U3	V3	Z3*				
BA10XE#180060	U4	V4	Z4*				

* Supplied with price surcharge of € 10.00

ELECTRIC VERSION WITH THERMOSTAT

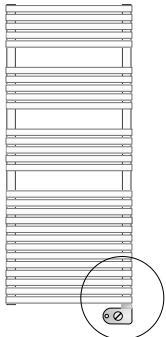

Electric
- Room Thermostat
- Radiator Thermostat

Model	Code Thermostat				H (cm)	L (cm)	Electric resistor Watts	Price Stainless steel (€)
	ROOM THERMOSTAT		RADIATOR					
	White	Chrome	White	Chrome				
BA10XE#080040	A5	A7	N1	N5	80,5	40,0	300	
BA10XE#080050	A5	A7	N1	N5				
BA10XE#080060	B5	B7	N2	N6				
BA10XE#120040	B5	B7	N2	N6	119,5	40,0	600	
BA10XE#120050	B5	B7	N2	N6				
BA10XE#120060	C5	C7	N3	N7				
BA10XE#150040	B5	B7	N2	N6	149,5	40,0	600	
BA10XE#150050	C5	C7	N3	N7				
BA10XE#150060	C5	C7	N3	N7				
BA10XE#180040	C5	C7	N3	N7	181,0	40,0	900	
BA10XE#180050	C5	C7	N3	N7				
BA10XE#180060	D5	D7	N4	N8				

ELECTRIC VERSION WITH WIRELESS THERMOSTAT

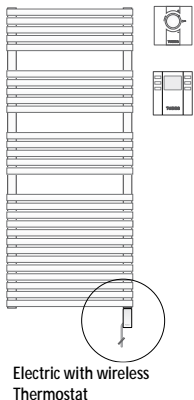

Electric with wireless Thermostat

Model	Edge Cap Colour Code			Wireless Thermostat Code		H (cm)	L (cm)	Electric resistor Watts	Price Stainless steel (€)
	White	Grey	Chrome*	Room Thermostat Kit	Chronothermostat Kit**				
				+ZRF004	+ZRF007**				
BA10XE#080040	U1	V1	Z1*	+ZRF004	+ZRF007**	80,5	40,0	300	
BA10XE#080050	U1	V1	Z1*	+ZRF004	+ZRF007**				
BA10XE#080060	U2	V2	Z2*	+ZRF004	+ZRF007**				
BA10XE#120040	U2	V2	Z2*	+ZRF004	+ZRF007**	119,5	40,0	600	
BA10XE#120050	U2	V2	Z2*	+ZRF004	+ZRF007**				
BA10XE#120060	U3	V3	Z3*	+ZRF004	+ZRF007**				
BA10XE#150040	U2	V2	Z2*	+ZRF004	+ZRF007**	149,5	40,0	600	
BA10XE#150050	U3	V3	Z3*	+ZRF004	+ZRF007**				
BA10XE#150060	U3	V3	Z3*	+ZRF004	+ZRF007**				
BA10XE#180040	U3	V3	Z3*	+ZRF004	+ZRF007**	181,0	40,0	900	
BA10XE#180050	U3	V3	Z3*	+ZRF004	+ZRF007**				
BA10XE#180060	U4	V4	Z4*	+ZRF004	+ZRF007**				

* Supplied with price surcharge of € 10.00 - ** The chronothermostat kit comes with an extra charge of € 80.00

The wireless ELECTRIC version consists of two articles, eg BA10XE#080040 U1 (Electric Towel warmer with white edge cap) + ZRF004 (Kit Roomthermostat) and the total price is shown in the table. If the customer chooses ZRF007 ** (Chronothermostat kit) at the price indicated in the table must be added the extra price of € 78.00

IXSTEEL BA10XM Mixed

Towel warmer composed of horizontal 10 mm diam. stainless steel elements fusion welded elements with 28 mm diam. manifolds

MX

ORDER EXAMPLE

To correctly order this model follow the example specified below:

PRODUCT **BA10XM#080050 KU1 ST SPA**
 BA10XM#080050 Article code found in the prices table on the side
 ST Standard Support code, only one support code available for Electric and Mixed version
 SPA Brushed stainless steel code

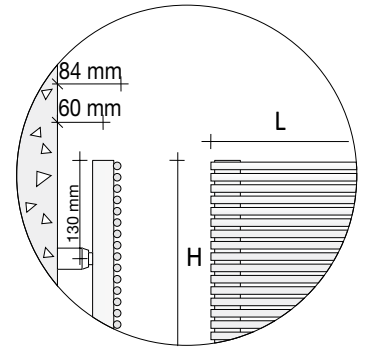

MIXED WITH KIT, EXTERNAL CONNECTOR WITH STANDARD VALVES (cod. BA10XM#...)

MIXED VERSION WITH KIT and external connectors

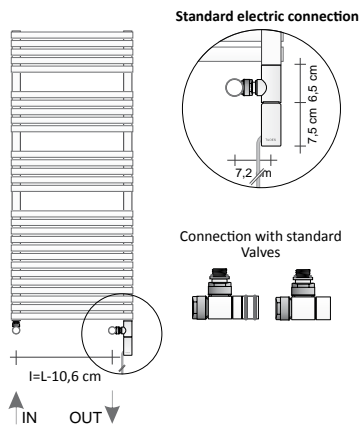

MIXED WITH KIT, REAR CONNECTOR WITH GVR (REMOTE VALVES) (cod. BA10XMS#...)

MIXED VERSION WITH EDGE CAP with rear connectors and GVR

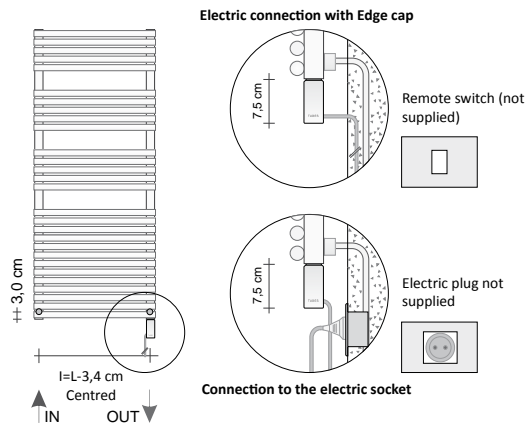

Connection to the Remote Valve Assembly (GVR)

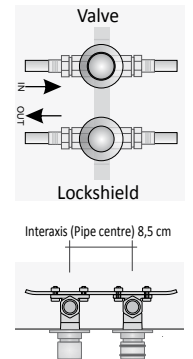

MIXED VERSION WITH KIT AND THERMOSTAT (Room) with external connectors

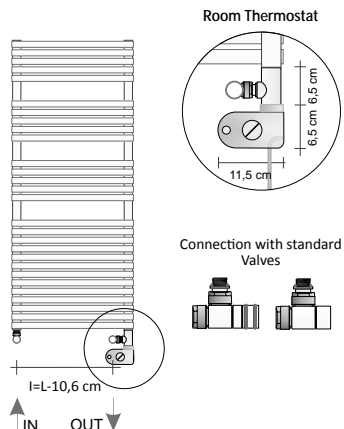

MIXED VERSION WITH THERMOSTAT (Room/Radiator) and rear connectors for GVR (Room/Radiator) and rear connectors for GVR

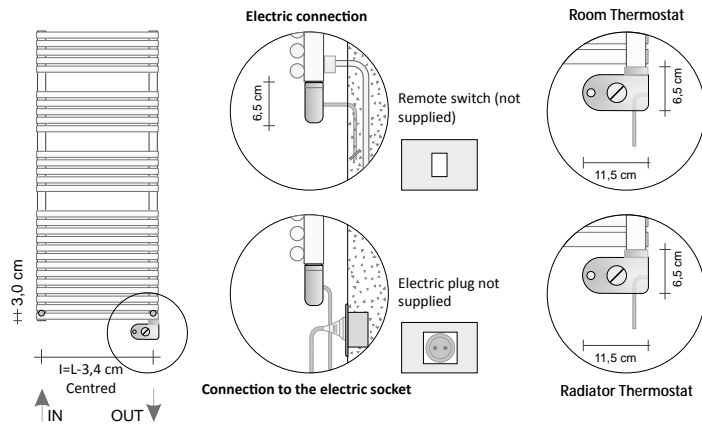

Connection to the Remote Valve Assembly (GVR)

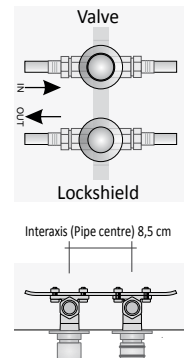

MIXED WITH KIT, WIRELESS THERMOSTAT and external connectors

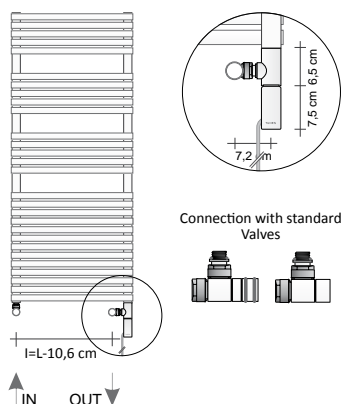

MIXED WITH KIT, WIRELESS THERMOSTAT and rear connectors

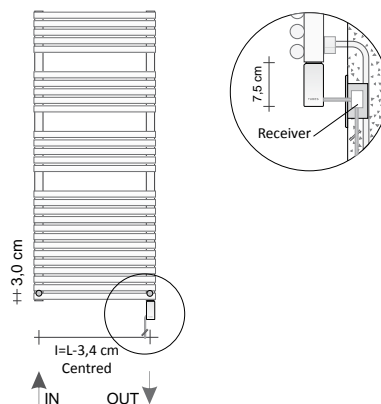

Wireless connections

Kit with wireless room thermostat (code ZRF004)

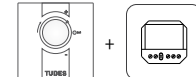

Programmable, Digital wireless chronothermostat (code ZRF007)



The Room Thermostat Kit and Chronothermostat Kit also includes the receiver for wireless connection

Connection to the Remote Valve Assembly (GVR)

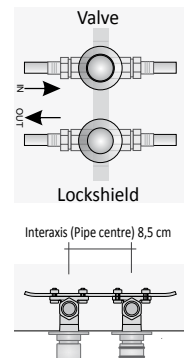

IXSTEEL BA10XM Mixed

Price for radiator with Stainless Steel finishing and standard connectors – VAT and transport charges excluded.



MIXED VERSION - (BA10XM means the version with kit and standard valves- BA10XMS means the version to be connected by GVR and rear connection)

Connectable Version via		Edge Cap Colour Code			H (cm)	L (cm)	Interaxis (Pipe centre) (cm)	Thermal yield		Electric resistor Watts	Price Stainless steel (€)		
Standard Valves	rear connector and GVR	White	Grey	Chrome*				Watts ΔT 50°C	Watts ΔT 30°C				
BA10XM#080040	BA10XMS#080040	KU1	KV1	KZ1*	80,5	40,0	29,4	297	155	300			
BA10XM#080050	BA10XMS#080050	KU1	KV1	KZ1*				50,0	39,4	398		208	300
BA10XM#080060	BA10XMS#080060	KU2	KV2	KZ2*				60,0	49,4	500		262	600
BA10XM#120040	BA10XMS#120040	KU2	KV2	KZ2*	119,5	40,0	29,4	434	225	600			
BA10XM#120050	BA10XMS#120050	KU2	KV2	KZ2*				50,0	39,4	552		289	600
BA10XM#120060	BA10XMS#120060	KU3	KV3	KZ3*				60,0	49,4	670		353	900
BA10XM#150040	BA10XMS#150040	KU2	KV2	KZ2*	149,5	40,0	29,4	546	282	600			
BA10XM#150050	BA10XMS#150050	KU3	KV3	KZ3*				50,0	39,4	678		354	900
BA10XM#150060	BA10XMS#150060	KU3	KV3	KZ3*				60,0	49,4	811		429	900
BA10XM#180040	BA10XMS#180040	KU3	KV3	KZ3*	181,0	40,0	29,4	665	343	900			
BA10XM#180050	BA10XMS#180050	KU3	KV3	KZ3*				50,0	39,4	829		432	900
BA10XM#180060	BA10XMS#180060	KU4	KV4	KZ4*				60,0	49,4	993		523	1200

* Supplied with price surcharge of € 10.00

MIXED VERSION WITH THERMOSTAT (Room/Radiator) and rear connectors for GVR - (BA10XM means the version with kit and standard valves- BA10XMS means the version to be connected by GVR and rear connection)

Connectable Version via		Code Thermostat				H (cm)	L (cm)	Interaxis (Pipe centre) (cm)	Thermal yield		Electric resistor Watts	Price Stainless steel (€)		
Standard Valves	rear connector and GVR	ROOM THERMOSTAT		RADIATOR					Watts ΔT 50°C	Watts ΔT 30°C				
		White	Chrome	White	Chrome									
BA10XM#080040	BA10XMS#080040	KA5	KA7	KN1	KN5	80,5	40,0	29,4	297	155	300			
BA10XM#080050	BA10XMS#080050	KA5	KA7	KN1	KN5				50,0	39,4	398		208	300
BA10XM#080060	BA10XMS#080060	KB5	KB7	KN2	KN6				60,0	49,4	500		262	600
BA10XM#120040	BA10XMS#120040	KB5	KB7	KN2	KN6	119,5	40,0	29,4	434	225	600			
BA10XM#120050	BA10XMS#120050	KB5	KB7	KN2	KN6				50,0	39,4	552		289	600
BA10XM#120060	BA10XMS#120060	KC5	KC7	KN3	KN7				60,0	49,4	670		353	900
BA10XM#150040	BA10XMS#150040	KB5	KB7	KN2	KN6	149,5	40,0	29,4	546	282	600			
BA10XM#150050	BA10XMS#150050	KC5	KC7	KN3	KN7				50,0	39,4	678		354	900
BA10XM#150060	BA10XMS#150060	KC5	KC7	KN3	KN7				60,0	49,4	811		429	900
BA10XM#180040	BA10XMS#180040	KC5	KC7	KN3	KN7	181,0	40,0	29,4	665	343	900			
BA10XM#180050	BA10XMS#180050	KC5	KC7	KN3	KN7				50,0	39,4	829		432	900
BA10XM#180060	BA10XMS#180060	KD5	KD7	KN4	KN8				60,0	49,4	993		523	1200

MIXED VERSION WITH WIRELESS THERMOSTAT - (BA10XM means the version with kit and standard valves- BA10XMS means the version to be connected by GVR and rear connection)

Connectable Version via		Edge Cap Colour Code				Wireless Thermostat Code		H (cm)	L (cm)	Interaxis (Pipe centre) (cm)	Thermal yield		Electric resistor Watts	Price Stainless steel (€)	
Standard Valves	rear connector and GVR	White	Grey	Chrome*	Room Thermostat Kit	Chronothermostat Kit**	Watts ΔT 50°C				Watts ΔT 30°C				
BA10XM#080040	BA10XMS#080040	KU1	KV1	KZ1*	+ZRF004	+ZRF007**	80,5	40,0	29,4	297	155	300			
BA10XM#080050	BA10XMS#080050	KU1	KV1	KZ1*	+ZRF004	+ZRF007**				50,0	39,4	398		208	300
BA10XM#080060	BA10XMS#080060	KU2	KV2	KZ2*	+ZRF004	+ZRF007**				60,0	49,4	500		262	600
BA10XM#120040	BA10XMS#120040	KU2	KV2	KZ2*	+ZRF004	+ZRF007**	119,5	40,0	29,4	434	225	600			
BA10XM#120050	BA10XMS#120050	KU2	KV2	KZ2*	+ZRF004	+ZRF007**				50,0	39,4	552		289	600
BA10XM#120060	BA10XMS#120060	KU3	KV3	KZ3*	+ZRF004	+ZRF007**				60,0	49,4	670		353	900
BA10XM#150040	BA10XMS#150040	KU2	KV2	KZ2*	+ZRF004	+ZRF007**	149,5	40,0	29,4	546	282	600			
BA10XM#150050	BA10XMS#150050	KU3	KV3	KZ3*	+ZRF004	+ZRF007**				50,0	39,4	678		354	900
BA10XM#150060	BA10XMS#150060	KU3	KV3	KZ3*	+ZRF004	+ZRF007**				60,0	49,4	811		429	900
BA10XM#180040	BA10XMS#180040	KU3	KV3	KZ3*	+ZRF004	+ZRF007**	181,0	40,0	29,4	665	343	900			
BA10XM#180050	BA10XMS#180050	KU3	KV3	KZ3*	+ZRF004	+ZRF007**				50,0	39,4	829		432	900
BA10XM#180060	BA10XMS#180060	KU4	KV4	KZ4*	+ZRF004	+ZRF007**				60,0	49,4	993		523	1200

* Supplied with price surcharge of € 10.00 - ** The chronothermostat kit comes with an extra charge of € 80.00

The wireless MIXED version consists of two articles, eg.: BA10XM#080040 KU1 (MIXED Towel warmer with white edge cap) + ZRF004 (Kit Roomthermostat) and the total price is shown in the table. If the customer chooses ZRF007 ** (Chronothermostat kit) at the price indicated in the table must be added the extra price of € 78.00

REMOTE VALVE ASSEMBLY

code	Description	Price
GVR#	Valve and Lockshield assembly for recessed remote connection, CHROME finish	€
GVR#	Valve and Lockshield assembly for recessed remote connection, COLOUR finish	€

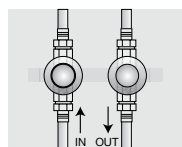

STANDARD VALVES (for Valves and Lockshields, valves that can be fitted with thermostat, Thermostatic valves, or Single pipe, Twin pipe, Stainless steel and thermostatic heads see pages 271, 272, 273, 274 und 275 of the Price List)

code / Description	Price
Z1TMNR#ANR12SPA Paired Valve and Lockshield copper Angle 1/2" STEEL	€
Z1RAC#R12SPA 2 copper unions diam. 12 mm	€
ZRCFG# Kit with pipe collars for towel warmers	€