

IXSTEEL XV 10 VERTICAL SINGLE

Radiator composed of 10 mm diameter stainless steel vertical elements fusion welded with 28 mm diameter manifolds

HW

ORDER EXAMPLE

To correctly order this model follow the example specified below:

PRODUCT **XV10#200 018 0C1 ST SPA**
 XV10#200 018 Article code composed of Model, Height (200) and Number of elements (018)
 0C1 Connector code found in the table here below
 ST Standard Support code found in the table here below
 SPA Brushed stainless steel code

ACCESSORIES
 Z1TMNR#AN R12 SPA Valve and Lockshield - stainless STEEL Copper Angle 1/2"
 Z1RACX#R12SPA 12mm diam. copper pipe unions for Valve+Lockshield – chrome finish (2)

For other types of Valves see the table below or those on pages 271 - 272 - 273 - 274 - 275.

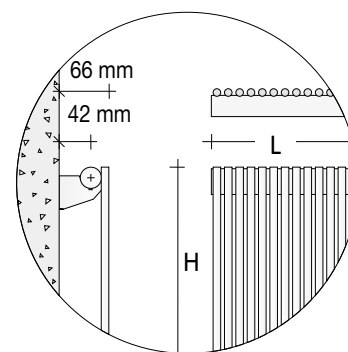

CONNECTORS

The radiators are supplied with "0C1" connectors as shown in the table here below.

If different connectors are required, strictly indicate this in the order. **IMPORTANT:** the connectors of the radiators ordered and the radiators connected to the same system should all have the same configuration otherwise operating problems could occur. The OB2 configuration should have two 1/8" diameter chrome-plated plugs on the head of the manifolds.

Standard connectors

Will be supplied if not otherwise specified when placing the order

Custom-made connectors

Supplied on request WITH an additional price charge of €

Connectors on request

Supplied on request WITHOUT an additional price charge

Custom-made connectors

Supplied on request WITH an additional price charge of €

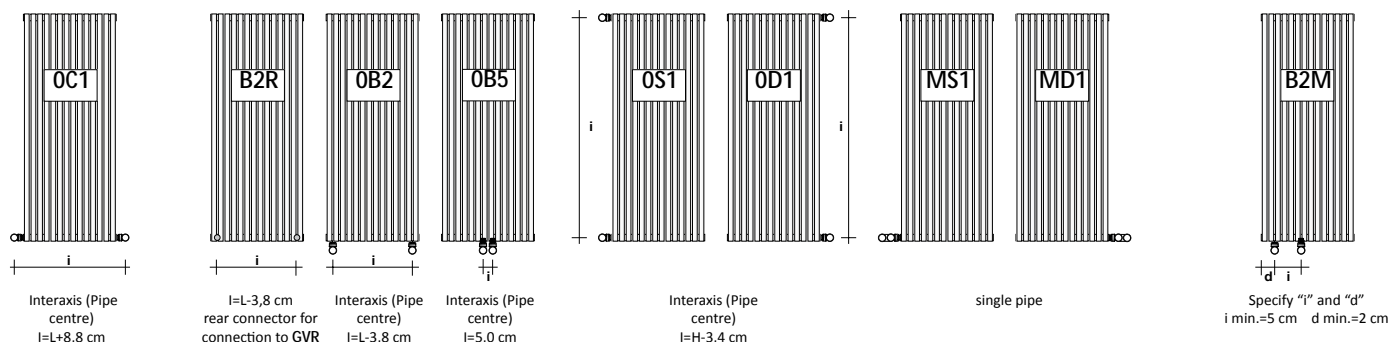

SUPPORTS

The radiators are supplied with standard supports (code ST) that include the wall fixing shelves and the manual vent Valve.

On request they can be ordered with bracket supports that are permanently welded on the towel warmers and therefore must be specified when placing the order, their code and cost are as follows:

code MD WALL TYPE bracket support on the Right €
 code MS WALL TYPE bracket support on the Left €
 code SO CEILING TYPE bracket support €

LIMITS

WALL TYPE bracket support Width max 59.4 cm
 CEILING TYPE bracket support All widths

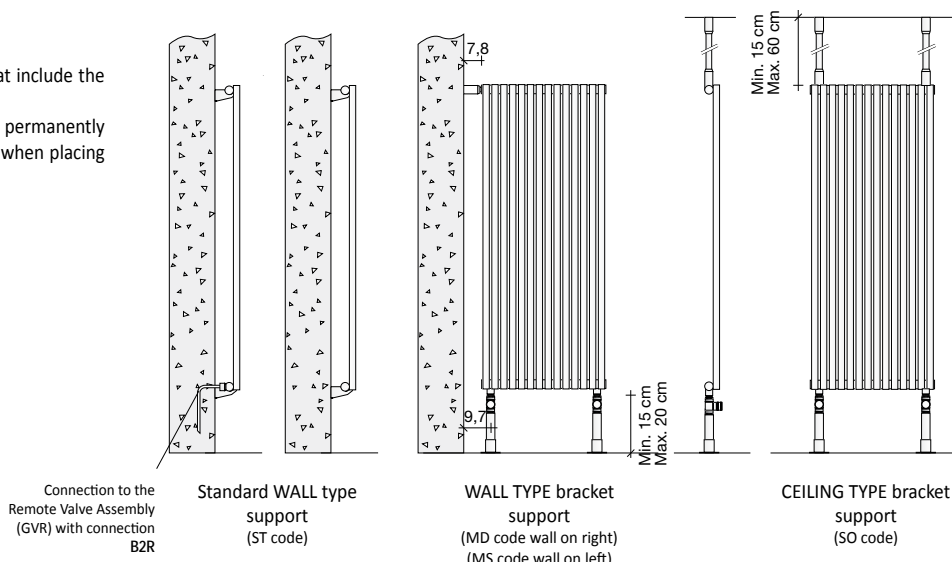

IXSTEEL XV 10 VERTICAL SINGLE

Price for items with BRUSHED finish and standard connectors. VAT and transport costs not included.

Thermal yield ΔT 50°C - Watts per radiator

For correction factors different to ΔT 50°C/ ΔT 30°C see page 284-289

Height		40		50		60		80		140		160		180		200		220		
N° elements	Width (cm)	Watts ΔT 50°C	Price (€)	Watts ΔT 50°C	Price (€)	Watts ΔT 50°C	Price (€)	Watts ΔT 50°C	Price (€)	Watts ΔT 50°C	Price (€)	Watts ΔT 50°C	Price (€)	Watts ΔT 50°C	Price (€)	Watts ΔT 50°C	Price (€)	Watts ΔT 50°C	Price (€)	
6	9,9	35		46		56		77		135		152		168		183		196		
8	12,9	47		61		75		103		180		203		224		244		262		
10	15,9	59		76		94		129		225		254		280		305		327		
12	18,9	71		91		113		155		270		305		336		366		392		
14	21,9	83		106		132		181		315		356		392		427		458		
16	24,9	94		122		150		206		360		406		448		488		523		
18	27,9	106		137		169		232		405		457		504		549		589		
20	30,9	118		152		188		258		450		508		560		610		654		
22	33,9	130		167		207		284		495		559		616		671		719		
24	36,9	142		182		226		310		540		610		672		732		785		
26	39,9	153		198		244		335		585		660		728		793		850		
28	42,9	165		213		263		361		630		711		784		854		916		
30	45,9	177		228		282		387		675		762		840		915		981		
32	48,9	189		243		301		413		720		813		896		976		1046		
34	51,9	201		258		320		439		765		864		952		1037		1112		
36	54,9	212		274		338		464		810		914		1008		1098		1177		
38	57,9	224		289		357		490		855		965		1064		1159		1243		
40	60,9	236		304		376		516		900		1016		1120		1220		1308		
42	63,9	248		319		395		542		945		1067		1176		1281		1373		
44	66,9	260		334		414		568		990		1118		1232		1342		1439		
46	69,9	271		350		432		593		1035		1168		1288		1403		1504		
48	72,9	283		365		451		619		1080		1219		1344		1464		1570		
50	75,9	295		380		470		645		1125		1270		1400		1525		1635		
Coefficient «n»		1,230	3,10	1,251	3,90	1,272	4,80	1,359	6,40	1,334	11,30	1,334	12,80	1,346	14,00	1,357	15,20	1,369	16,20	
Watt ΔT 30°C x Elem.																				

SIZES AVAILABLE ON REQUEST: H.70/90/100/110/120/130/150/170/190

REMOTE VALVE ASSEMBLY

code	Description	Price
GVR#	Valve and Lockshield assembly for recessed remote connection, CHROME finish	€
GVR#	Valve and Lockshield assembly for recessed remote connection, COLOUR finish	€

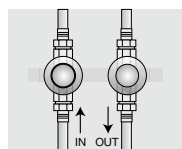

STANDARD VALVES (for Valves and Lockshields, valves that can be fitted with thermostat, Thermostatic valves, or Single pipe, Twin pipe, Stainless steel and thermostatic heads see pages 271, 272, 273, 274 and 275 of the Price List)

code / Description	Price
Z1TMNR#ANR12SPA Paired Valve and Lockshield copper Angle 1/2" STEEL	€
Z1RACX#R12SPA 2 copper unions diam. 12 mm	€
ZRCF2# Kit with pipe collars	€

IXSTEEL XV 10D VERTICAL DOUBLE

Radiator composed of 10 mm diameter stainless steel vertical elements fusion welded with 28 mm diameter manifolds

HW

ORDER EXAMPLE

To correctly order this model follow the example specified below:

PRODUCT **XV10D#200 018 0C1 ST SPA**
 XV10D#200 018 Article code composed of Model, Height (200) and Number of elements (018)
 0C1 Connector code found in the table here below
 ST Standard Support code found in the table here below
 SPA Brushed stainless steel code

ACCESSORIES
 Z1TMNR#AN R12 SPA Valve and Lockshield - stainless STEEL Copper Angle 1/2"
 Z1RACX#R12SPA 12mm diam. copper pipe unions for Valve+Lockshield – chrome finish (2)

For other types of Valves see the table below or those on pages 271 - 272 - 273 - 274 - 275.

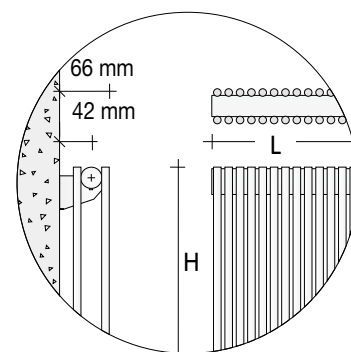

CONNECTORS

The radiators are supplied with "0C1" connectors as shown in the table here below.

If different connectors are required, strictly indicate this in the order. **IMPORTANT:** the connectors of the radiators ordered and the radiators connected to the same system should all have the same configuration otherwise operating problems could occur. The OB2 configuration should have two 1/8" diameter chrome-plated plugs on the head of the manifolds.

Standard connectors

Will be supplied if not otherwise specified when placing the order

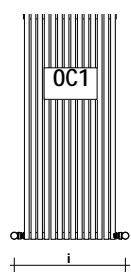

Interaxis (Pipe centre)
 $I=L+8,8$ cm

Custom-made connectors

Supplied on request WITH an additional price charge of €

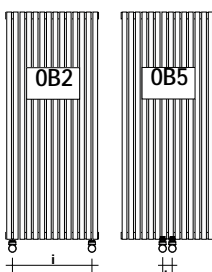

Interaxis (Pipe centre)
 $I=L-3,8$ cm

Interaxis (Pipe centre)
 $I=5,0$ cm

Connectors on request

Supplied on request WITHOUT an additional price charge

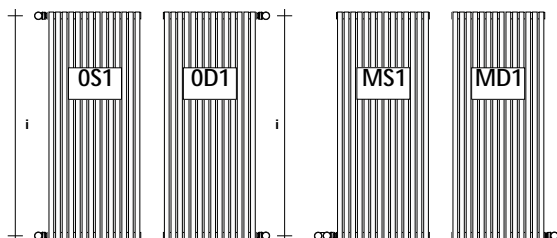

Interaxis (Pipe centre)
 $I=H-3,4$ cm

single pipe

Custom-made connectors

Supplied on request WITH an additional price charge of €

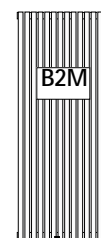

Specify "i" and "d"
 $i \text{ min.}=5$ cm $d \text{ min.}=2$ cm

SUPPORTS

The radiators are supplied with standard supports (code ST) that include the wall fixing shelves and the manual vent Valve.

On request they can be ordered with bracket supports that are permanently welded on the towel warmers and therefore must be specified when placing the order, their code and cost are as follows:

- code MD WALL TYPE bracket support on the Right €
- code MS WALL TYPE bracket support on the Left €
- code SO CEILING TYPE bracket support €

LIMITS

- WALL TYPE bracket support Width max 39.9 cm
- CEILING TYPE bracket support All widths

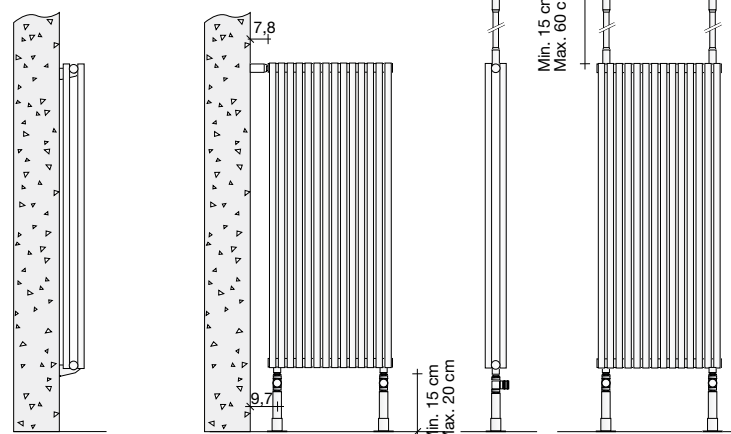

Standard WALL type support (ST code)

WALL TYPE bracket support (MD code wall on right) (MS code wall on left)

CEILING TYPE bracket support (SO code)

IXSTEEL XV 10D VERTICAL DOUBLE

Price for items with BRUSHED finish and standard connectors. VAT and transport costs not included.



Thermal yield ΔT 50°C - Watts per radiator

For correction factors different to ΔT 50°C/ ΔT 30°C see page 284-289

Height		40		50		60		80		140		160		180		200		220	
N° elements	Width (cm)	Watts ΔT 50°C	Price (€)	Watts ΔT 50°C	Price (€)	Watts ΔT 50°C	Price (€)	Watts ΔT 50°C	Price (€)	Watts ΔT 50°C	Price (€)	Watts ΔT 50°C	Price (€)	Watts ΔT 50°C	Price (€)	Watts ΔT 50°C	Price (€)	Watts ΔT 50°C	Price (€)
6	9,9	71		85		99		125		195		216		237		257		277	
8	12,9	94		114		132		166		260		288		316		342		369	
10	15,9	118		142		165		208		325		360		395		428		461	
12	18,9	142		170		198		250		390		432		474		514		553	
14	21,9	165		199		231		291		455		504		553		599		645	
16	24,9	189		227		264		333		520		576		632		685		738	
18	27,9	212		256		297		374		585		648		711		770		830	
20	30,9	236		284		330		416		650		720		790		856		922	
22	33,9	260		312		363		458		715		792		869		942		1014	
24	36,9	283		341		396		499		780		864		948		1027		1106	
26	39,9	307		369		429		541		845		936		1027		1113		1199	
28	42,9	330		398		462		582		910		1008		1106		1198		1291	
30	45,9	354		426		495		624		975		1080		1185		1284		1383	
32	48,9	378		454		528		666		1040		1152		1264		1370		1475	
34	51,9	401		483		561		707		1105		1224		1343		1455		1567	
Coefficient «n» Watt ΔT 30°C x Elem.		1,300	6,00	1,314	7,20	1,329	8,30	1,359	10,20	1,381	16,00	1,383	17,70	1,392	19,40	1,400	20,90	1,409	22,40

SIZES AVAILABLE ON REQUEST: H. 70/90/100/110/120/130/150/170/190

STANDARD VALVES (for Valves and Lockshields, valves that can be fitted with thermostat, Thermostatic valves, or Single pipe, Twin pipe, Stainless steel and thermostatic heads see pages 271, 272, 273, 274 and 275 of the Price List)

code / Description		Price
	Z1TMNR#ANR12SPA Paired Valve and Lockshield copper Angle 1/2" STEEL	STAINLESS €
	Z1RACX#R12SPA 2 copper unions diam. 12 mm	STAINLESS STEEL €
	ZRCF2# Kit with pipe collars	CHROME €

IXSTEEL XO10 HORIZONTAL SINGLE

Radiator composed of 10mm diameter horizontal elements in stainless steel fusion welded with 28 mm diameter manifolds

HW

ORDER EXAMPLE

To correctly order this model follow the example specified below:

PRODUCT	XO10#200 018 OB1 ST SPA
XO10#200 018	Article code composed of Model, Width (200) and Number of elements (018)
OB1	Connector code found in the table here below
ST	Standard Support code found in the table here below
SPA	Brushed stainless steel code
ACCESSORIES	
Z1TMNR#AN R12 SPA	Valve and Lockshield - stainless STEEL Copper Angle 1/2"
Z1RACX#R12SPA	12mm diam. copper pipe unions for Valve+Lockshield – chrome finish (2)

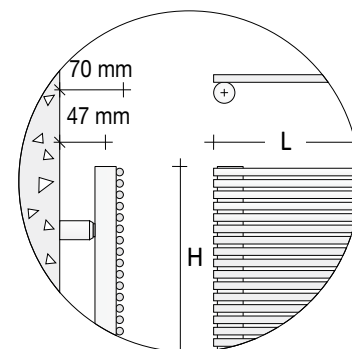

For other types of Valves see the table below or those on pages 271 - 272 - 273 - 274 - 275.

CONNECTORS

The radiators are supplied with "OB1" connectors as shown in the table here below.

If different connectors are required, strictly indicate this in the order. **IMPORTANT:** the connectors of towel warmers and radiators connected to the same system should all have the same configuration otherwise operating problems could occur.

Standard connectors

Will be supplied if not otherwise specified when placing the order

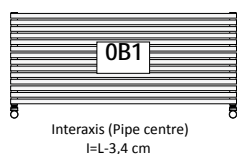

Custom-made connectors

Supplied on request WITH an additional price charge of €

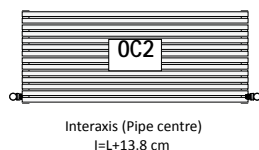
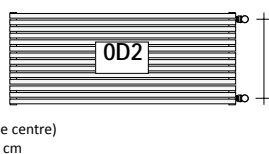
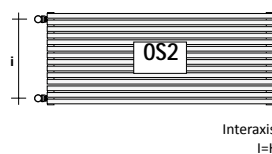

Connectors on request

Supplied on request WITHOUT an additional price charge

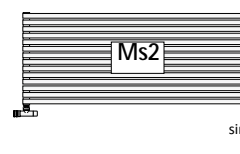

Custom-made connectors

Supplied on request WITH an additional price charge of €

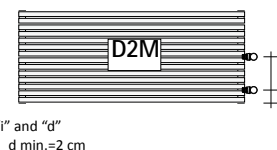
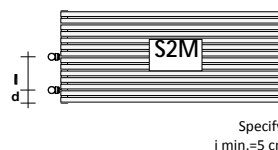

Specify "i" and "d"
i min.=5 cm d min.=2 cm

SUPPORTS

The radiators are supplied with standard supports (code ST) that include the wall fixing shelves and the manual vent Valve.

On request they can be ordered with bracket supports that are permanently welded on the towel warmers and therefore must be specified when placing the order, their code and cost are as follows:

code MD	WALL TYPE bracket support on the Right	€
code MS	WALL TYPE bracket support on the Left	€
code SO	CEILING TYPE bracket support	€

LIMITS

WALL TYPE bracket support	Width max 60.0 cm
CEILING TYPE bracket support	Width max 80.0 cm

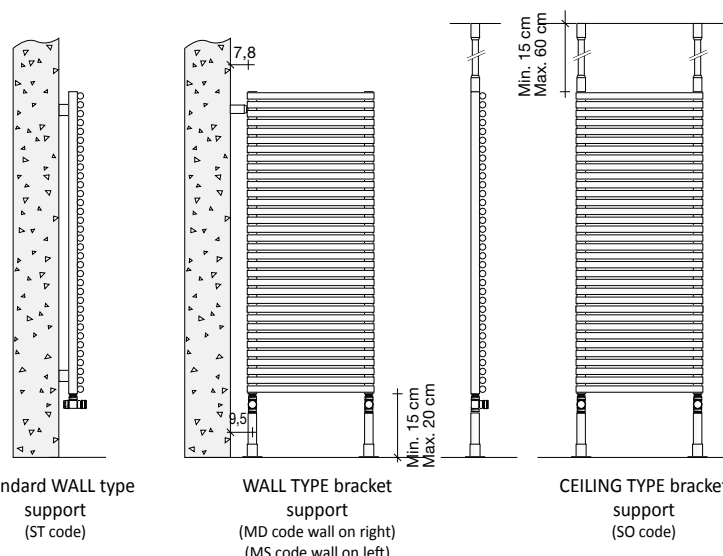

IXSTEEL XO10 HORIZONTAL SINGLE

Price for items with BRUSHED finish and standard connectors. VAT and transport costs not included.



Thermal yield ΔT 50°C - Watts per radiator

For correction factors different to ΔT 50°C/ ΔT 30°C see page 284-289

Width		40		50		60		80		140		160		180		200		220	
N° elements	Height (cm)	Watts ΔT 50°C	Price (€)	Watts ΔT 50°C	Price (€)	Watts ΔT 50°C	Price (€)	Watts ΔT 50°C	Price (€)	Watts ΔT 50°C	Price (€)	Watts ΔT 50°C	Price (€)	Watts ΔT 50°C	Price (€)	Watts ΔT 50°C	Price (€)	Watts ΔT 50°C	Price (€)
6	9,9	41		51		61		81		142		162		183		203		223	
8	12,9	54		67		81		108		189		216		243		270		297	
10	15,9	68		85		101		135		237		271		304		338		372	
12	18,9	82		102		122		163		286		326		367		408		449	
14	21,9	96		120		144		191		335		383		431		479		526	
16	24,9	110		138		165		220		385		440		495		550		605	
18	27,9	125		156		187		249		436		498		561		623		685	
20	30,9	139		174		209		278		487		557		627		696		766	
22	33,9	154		193		231		308		539		616		693		770		847	
24	36,9	169		211		254		338		592		676		761		845		930	
26	39,9	184		230		276		368		645		737		829		921		1013	
28	42,9	199		249		299		399		698		798		897		997		1097	
30	45,9	215		268		322		430		752		859		966		1074		1181	
32	48,9	230		288		345		461		806		921		1036		1151		1267	
34	51,9	246		308		370		493		862		986		1109		1232		1355	
36	54,9	262		327		392		523		916		1047		1177		1308		1439	
38	57,9	277		347		416		555		971		1110		1249		1387		1526	
40	60,9	293		367		440		587		1027		1174		1320		1467		1614	
42	63,9	310		387		464		619		1083		1238		1393		1548		1702	
44	66,9	326		407		489		651		1140		1303		1466		1629		1791	
46	69,9	342		428		513		684		1197		1368		1539		1710		1881	
48	72,9	358		448		538		717		1255		1434		1613		1792		1971	
50	75,9	375		469		562		750		1312		1500		1687		1875		2062	
ΔT 30°C x Elem.		3,60		4,40		5,20		6,70		11,90		13,60		15,20		16,00		18,40	

SIZES AVAILABLE ON REQUEST: L.70/90/100/110/120/130/150/170/190

STANDARD VALVES (for Valves and Lockshields, valves that can be fitted with thermostat, Thermostatic valves, or Single pipe, Twin pipe, Stainless steel and thermostatic heads see pages 271, 272, 273, 274 and 275 of the Price List)

code / Description		Price
	Z1TMNR#ANR12SPA Paired Valve and Lockshield copper Angle 1/2" STEEL	STAINLESS €
	Z1RACX#R12SPA 2 copper unions diam. 12 mm	STAINLESS STEEL €
	ZRFC2# Kit with pipe collars	CHROME €

IXSTEEL XO10D HORIZONTAL DOUBLE

Radiator composed of 10mm diameter horizontal elements in stainless steel fusion welded with 28 mm diameter manifolds

HW

ORDER EXAMPLE

To correctly order this model follow the example specified below:

PRODUCT	XO10D#200 018 OB1 ST SPA
XO10D#200 018	Article code composed of Model, Width (200) and Number of elements (018)
OB1	Connector code found in the table here below
ST	Standard Support code found in the table here below
SPA	Brushed stainless steel code
ACCESSORIES	
Z1TMNR#AN R12 SPA	Valve and Lockshield - stainless STEEL Copper Angle 1/2"
Z1RACX#R12SPA	12mm diam. copper pipe unions for Valve+Lockshield – chrome finish (2)

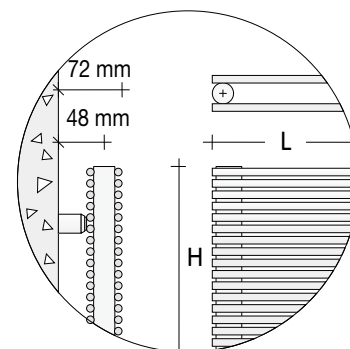

For other types of Valves see the table below or those on pages 271 - 272 - 273 - 274 - 275.

CONNECTORS

The radiators are supplied with "OB1" connectors as shown in the table here below.

If different connectors are required, strictly indicate this in the order. **IMPORTANT:** the connectors of towel warmers and radiators connected to the same system should all have the same configuration otherwise operating problems could occur.

Standard connectors

Will be supplied if not otherwise specified when placing the order

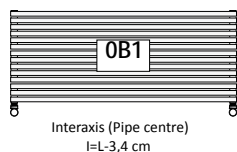

Custom-made connectors

Supplied on request WITH an additional price charge of €

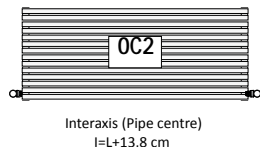
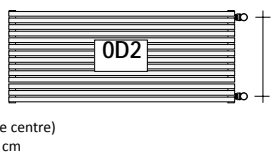
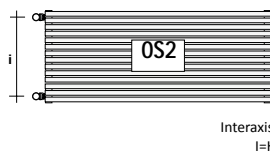

Connectors on request

Supplied on request WITHOUT an additional price charge

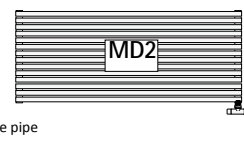
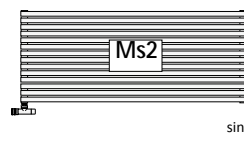

Custom-made connectors

Supplied on request WITH an additional price charge of €

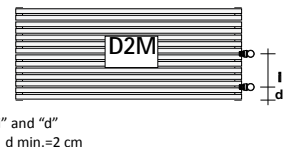
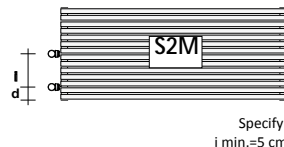

Specify "i" and "d"
i min.=5 cm d min.=2 cm

SUPPORTS

The radiators are supplied with standard supports (code ST) that include the wall fixing shelves and the manual vent Valve.

On request they can be ordered with bracket supports that are permanently welded on the towel warmers and therefore must be specified when placing the order, their code and cost are as follows:

code MD	WALL TYPE bracket support on the Right	€
code MS	WALL TYPE bracket support on the Left	€
code SO	CEILING TYPE bracket support	€

LIMITS

WALL TYPE bracket support	Width max 40.0 cm
CEILING TYPE bracket support	Width max 60.0 cm

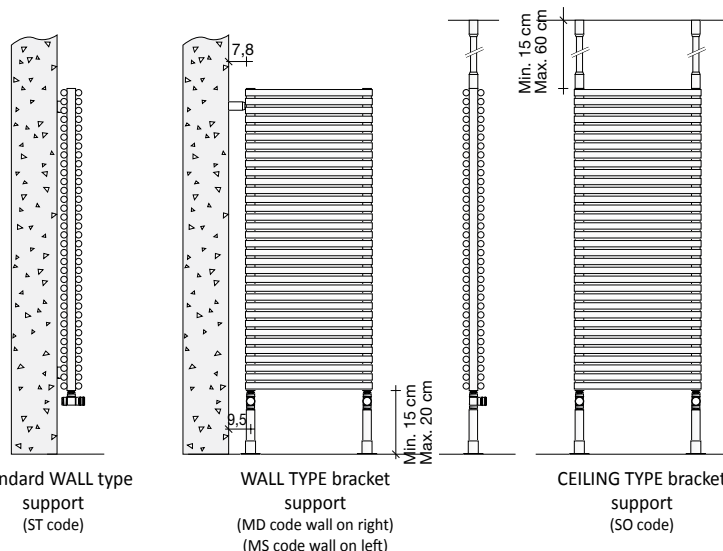

IXSTEEL XO10D HORIZONTAL DOUBLE

Price for items with BRUSHED finish and standard connectors. VAT and transport costs not included.



Thermal yield ΔT 50°C - Watts per radiator

For correction factors different to ΔT 50°C/ ΔT 30°C see page 284-289

Width		40		50		60		80		140		160		180		200		220	
N° elements	Height (cm)	Watts ΔT 50°C	Price (€)	Watts ΔT 50°C	Price (€)	Watts ΔT 50°C	Price (€)	Watts ΔT 50°C	Price (€)	Watts ΔT 50°C	Price (€)	Watts ΔT 50°C	Price (€)	Watts ΔT 50°C	Price (€)	Watts ΔT 50°C	Price (€)	Watts ΔT 50°C	Price (€)
6	9,9	82		103		124		165		289		330		371		412		453	
8	12,9	104		130		156		208		365		417		469		521		573	
10	15,9	126		157		188		251		440		502		565		628		691	
12	18,9	147		184		221		294		515		588		662		735		809	
14	21,9	168		211		253		337		589		674		758		842		926	
16	24,9	190		237		285		380		665		760		855		950		1045	
18	27,9	212		265		317		423		741		846		952		1058		1164	
20	30,9	233		292		350		467		817		934		1050		1167		1284	
22	33,9	256		319		383		511		894		1022		1150		1278		1406	
24	36,9	278		347		417		556		973		1112		1251		1390		1529	
26	39,9	301		376		451		601		1052		1202		1353		1503		1653	
28	42,9	324		404		485		647		1132		1294		1456		1618		1780	
30	45,9	347		434		520		694		1214		1388		1561		1734		1908	
32	48,9	371		463		556		741		1297		1482		1668		1853		2038	
34	51,9	395		493		592		789		1381		1578		1776		1973		2170	
ΔT 30°C x Elem.		5,90		7,20		7,20		11,50		19,90		22,70		25,50		28,20		30,90	

SIZES AVAILABLE ON REQUEST: L.70/90/100/110/120/130/150/170/190

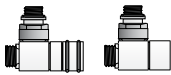
STANDARD VALVES (for Valves and Lockshields, valves that can be fitted with thermostat, Thermostatic valves, or Single pipe, Twin pipe, Stainless steel and thermostatic heads see pages 271, 272, 273, 274 und 275 of the Price List)

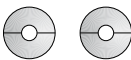
code / Description		Price
	Z1TMNR#ANR12SPA Paired Valve and Lockshield copper Angle 1/2" STEEL	STAINLESS €
	Z1RACX#R12SPA 2 copper unions diam. 12 mm	STAINLESS STEEL €
	ZRCF2# Kit with pipe collars	CHROME €